

PERFORMANCE DATA SHEET

67257 WaterBasics™ Emergency Pump and Filter Kit

General Use Information

The WaterBasics Pump and Filter Kit is designed to provide easy dispensing of stored emergency water and can be operated with or without the included filter. The system includes all the parts necessary to connect to most standard water containers. The retractable hose allows the user to fill containers up to 10 feet away from the storage container and conveniently stores on top of the container when not in use. A shut-off valve is included to prevent flow when not in use. The RED Line filter provides biological protection from cysts, bacteria and viruses. The system can be used with or without the RED Line filter but all health claims pertain only to the complete system with the RED Line filter correctly installed per the User Manual.

Important Safety Information

CAUTION - Do not connect pump directly to a pressurized water source, such as an inside or outside faucet. Incorrect use may result in damage or injury.

CAUTION - Pump and hose kit contain small parts. Keep away from Children.

General Maintenance

FILTER STORAGE - Filter may be stored wet for short periods of time. (<30 days) For long term storage (>30 days), Remove filter from Pump, remove excess water and allow to dry for a minimum of 48 hours. Store in a cool dry location. Do not store used filter in a sealed container. Do not freeze filter or expose filter to extreme temperatures.

PUMP, HOSE, AND FITTINGS STORAGE - Remove residual water, allow to air dry.

Replacement Parts

67259 WaterBasics Replacement Filter (RED-II-120)

Warranty and Disclaimer

Aquamira Technologies, Inc. (Aquamira) warrants all products to be free from defects in workmanship and materials for one year from the date of purchase by the consumer, or for the duration of the imprinted self life. Filter clogging or normal wear is not a defect. If you are not satisfied with the performance of an Aquamira product, Aquamira will repair or replace the product.

Aquamira hereby excludes any expressed or implied warranties of fitness for a particular purpose. The following is made in lieu of any such warranties: This information and specifications supplied by Aquamira are based on industry standards and are tested using standard laboratory test conditions which are accepted in the industry to be reliable, but Aquamira does not guarantee that any result shown or claimed will be obtained. Before using any Aquamira product, the user shall determine the suitability and the fitness of the products for their intended use. The effectiveness of Aquamira products may be limited by environmental or hygienic conditions, such as use with contaminated hands, recontamination after filtration or treatment, failure to maintain a sterile mouthpiece or downstream equipment, sharing with multiple users, exposure to extreme environmental conditions such as heat, freezing, severe shock such as drops or other impact that may damage the integrity of filters, seals or connections. The user assumes all risk and liability in connection with its own tests and use. Aquamira shall not be liable for any injury, loss or damage, direct or consequential, resulting by or from the use, misuse, or inability to use Aquamira products.

While testing was performed under standard laboratory conditions, actual performance may vary.



Product Data and Dimensions

DIMENSIONS	12 x 4.5 x 4.5 inches
DRY WEIGHT	1.61 lbs (730 g)
FLOW RATE	.05 - .21 gpm (200 - 500 ml/min)
SERVICE LIFE (FILTER)	120 gal (454.248 L)
OP. TEMPS	35 - 120°F (1.6 - 49°C)
OP. PRESSURE (FILTER)	3psi (20.6844kPa)

Recommended Use Conditions

Use best water source available, quality of the source water may vary, use only Aquamira RED Line Series II filters if biological quality of source water is uncertain.

Assembled in US of US & Global Components. Filter made in the USA.

EPA Est. No 71766-UT-001

Certifications



Certified by IAPMO R&T to US EPA Microbiological Purifier test standard for the reduction of cysts, bacteria and viruses. Certified to NSF/ANSI 372 for lead free content.

Performance Specifications

RED LINE		VIRUS PROTECTION
Virus Removal	≥99.99%	
Bacteria Removal	≥99.9999%	
Cyst Removal	≥99.95%	
MEETS US EPA BIOLOGICAL PURIFIER TEST STANDARD		
Chlorine, Chemical, Taste & Odor Removal		
MEETS OR EXCEEDS ANSI/NSF 42		

EMERGENCY PUMP & FILTER KIT

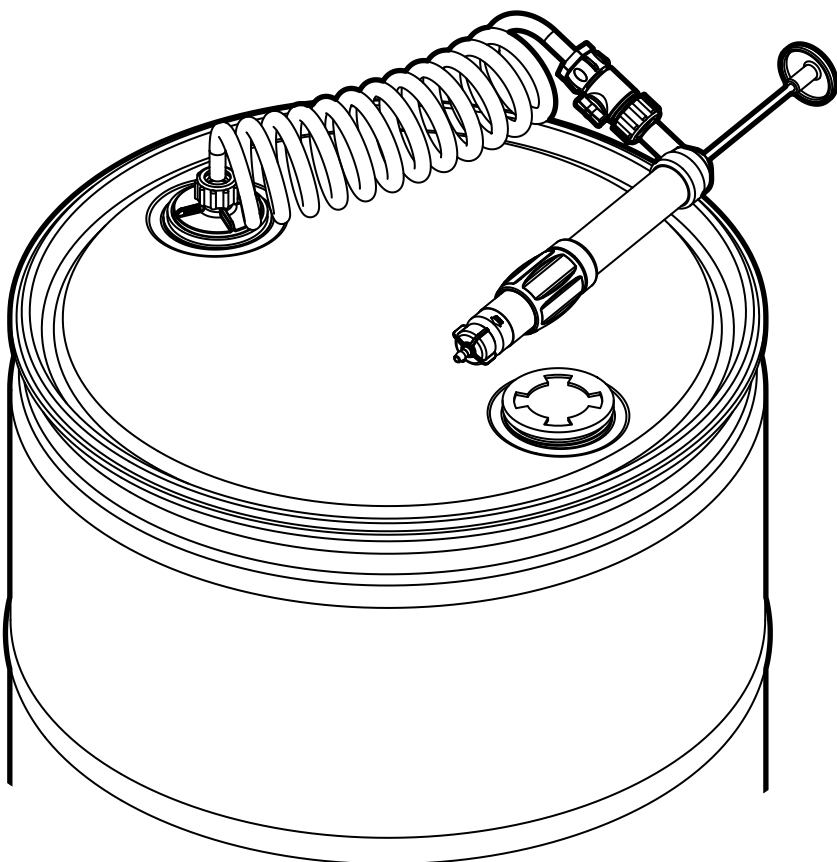

USER MANUAL

Model Number 67257

EMERGENCY PUMP AND FILTER KIT

INTRODUCTION

Thank you for purchasing The WaterBasics® Pump and Filter Kit! You have taken an important step toward being prepared for any water emergency that compromises the safety of your drinking water supply.

We welcome you to the growing family of WaterBasics owners, who have made life-saving water a priority.

KIT FEATURES

- **Quick and easy set-up**
- **Easy to transport and store**
- **Ideal for emergencies or recreational use**
- **Patented Bung Adapter provides access to liner and works with 55/30 gallon drums**
- **Easy to operate hand pump can be used with or without a filter**
- **Telescoping draw tubes adapt to a variety of container sizes**
- **Fitting kit has multiple adapters for easy filling and draining options**

EMERGENCY WATER STORAGE TIPS

Water is necessary for survival and an essential component of emergency preparedness. Most likely, clean drinking water will not be available immediately following a disaster. Municipal water supplies may be cut off or compromised because of damage or contamination.

PLAN AHEAD - BE PREPARED

- **Plan for 1 gallon of water per person per day for drinking and sanitation**
- **Store or provide capacity for a 3-6 day supply of water per person**
- **The elderly, children, and nursing mothers require more water**
- **Water requirements double in hot temperatures**
- **Medical situations will require more water**

IMPORTANT SAFETY INFORMATION

NOTICES

- **Avoid freezing temperatures**
- **To avoid cross contamination: Do not handle filter with wet hands that have been exposed to contaminated water. Do not submerge filter in water**

CAUTIONARY STATEMENTS

CAUTION — Pump and hose kit contain small parts. Keep away from Children.

CAUTION — Do not connect pump directly to a pressurized water source, such as an inside or outside faucet. Incorrect use may result in damage or injury.

CAUTION!

DO NOT connect pump directly to a pressurized water source, such as an inside or outside faucet. Incorrect use may result in damage or injury.

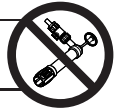

LIMITED WARRANTY AND DISCLAIMER

Aquamira warrants all products to be free from defects in workmanship and materials for one year from the date of purchase by the consumer, or for the duration of the imprinted shelf life. Filter clogging or normal wear is not a defect. If you are not satisfied with the performance of an Aquamira product, Aquamira will repair or replace the product.

Aquamira Technologies, Inc. (Aquamira) hereby excludes any expressed or implied warranties of fitness for a particular purpose. The following is made in lieu of any such warranties: The information and specifications supplied by Aquamira are based on industry standards and are tested using standard laboratory test conditions which are accepted in the industry to be reliable. Aquamira does not guarantee that any result shown or claimed will be obtained. Before using any Aquamira product, the user shall determine the suitability and the fitness of the products for their intended use. The effectiveness of Aquamira products may be limited by environmental or hygienic conditions, such as use with contaminated hands, recontamination after filtration or treatment, failure to maintain a sterile mouthpiece or downstream equipment, sharing with multiple users, exposure to extreme environmental conditions such as heat, freezing, severe shock such as drops or other impact that may damage the integrity of filters, seals or connections. The user assumes all risk and liability in connection with its own tests and use. Aquamira shall not be liable for any injury, loss or damage, direct or consequential, resulting by or from the use, misuse, or inability to use Aquamira products.

WATER STORAGE KIT

COMPONENTS

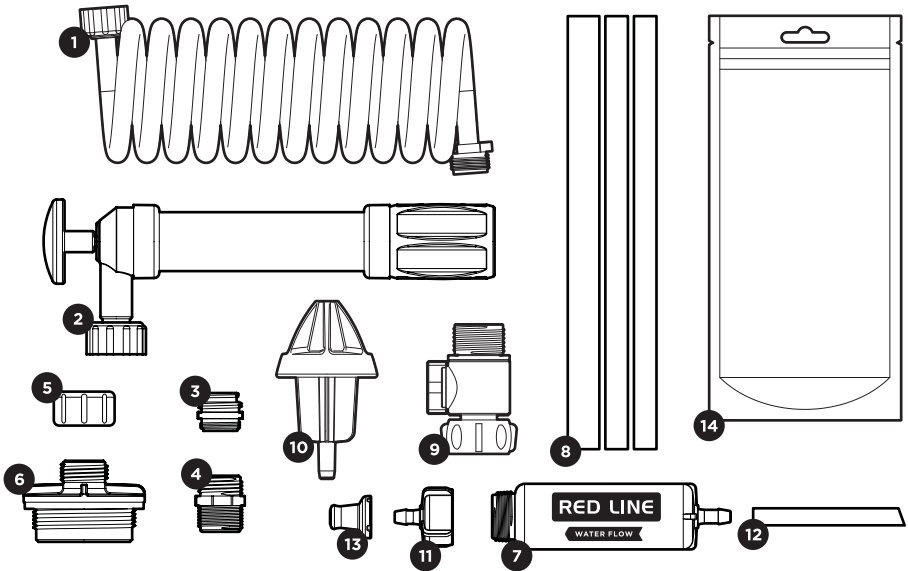

PARTS LIST

PART #	ITEM NAME
1	071452 Hose
2	071451 Pump
3	Faucet Adapter (available at local hardware store)
4	014413-033 3/4" Pipe Thread to Garden Hose Adapter
5	071412-033 Garden Hose Cap
6	071400 Adapter Cap
7	67259 WaterBasics RED Line Series II Filter
8	050120, 050121 Telescoping Tubes
9	045719 Valve
10	045268 Nozzle
11	045294 Barbed Adapter
12	050110 Straw
13	047570 Mouthpiece
14	016666 Pouch

PRODUCT INSTRUCTIONS

HOW TO PUMP AND FILTER WATER FROM RIGID CONTAINER

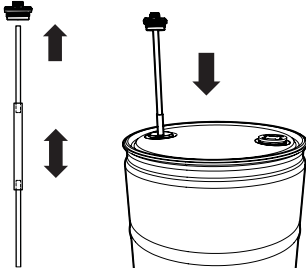

STEP 1

Adjust telescoping tube **8** length to extend to the bottom of the water storage container, then attach to inside of the adapter cap **6**.

Thread the patented adapter cap **6** into the bung fitting on the container.

Note: barrels have one fine and one coarse thread fitting. Use the fine threaded fitting.

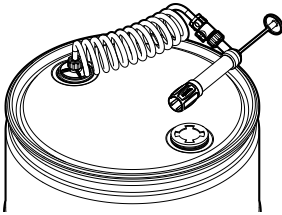

STEP 2

Attach hose **1**, and pump **2**, and valve **9** to the adapter cap **6** as shown.

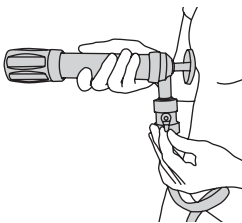

STEP 3

Valve **9** Operation Notice:

Open valve **9** before use, close valve **9** after use.

(Valve is shown in OPEN position)

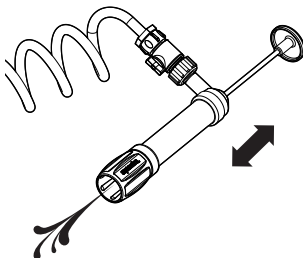

STEP 4

Flush and prime the pump **2** by pumping until all air is evacuated from the pump **2**. Each stroke should expel a steady stream of water without bubbles or spurts.

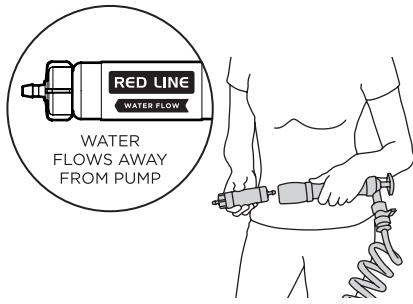

STEP 5

Locate the flow direction on the filter **7** and press the INLET end of the filter **7** firmly into the OUTLET end of the pump **2**.

When using a new or dry filter **7** the filter media will trap some air slowing the flow until the media is thoroughly wetted and the air is expelled. Allow several minutes of pumping to purge the air from the filter.

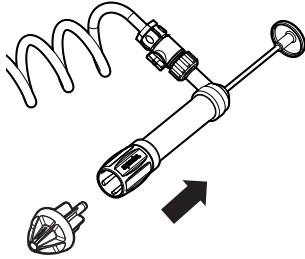

If dispensing water without filtering
Press the nozzle **10** firmly into the OUTLET end of the pump **2**.



STEP 6

Pump with steady strokes to dispense filtered water into clean containers for use.

When not dispensing water, turn the valve **9** to the CLOSED position.

HOW TO PUMP AND FILTER WATER TO 5 GAL CONTAINER

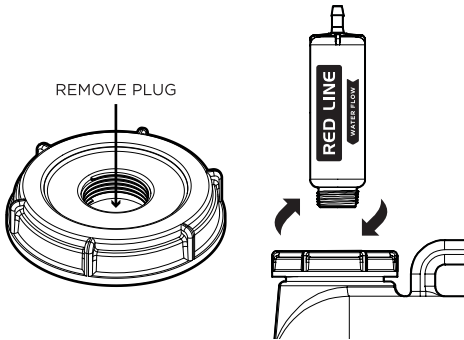

STEP 7

Remove the plug at the bottom of the inner threaded opening of the container cap as shown. Remove the adapter **11** and thread the filter **7** into the cap of the 5 gallon container as shown.

Note: Remove the barbed adapter **11** from the filter **10** to reveal threads.

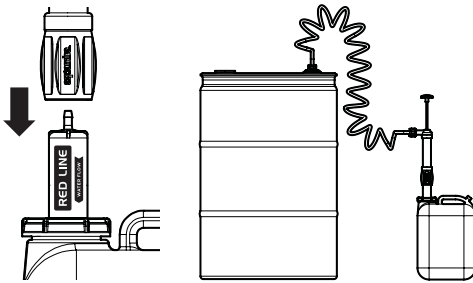

STEP 8

Purge the pump **2** of air, then press the OUTLET end of the pump **2** onto the INLET end of the filter **7** as shown. Begin pumping water into container.

HOW TO PUMP AND FILTER WATER FROM 5 GAL CONTAINER

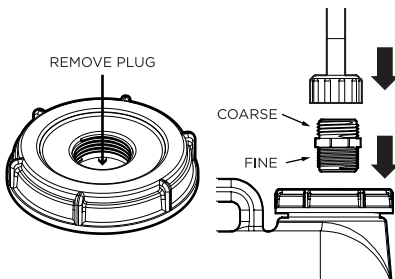

STEP 9

Remove the plug at the bottom of the inner threaded opening of the container cap as shown. Attach garden hose adapter **4** to the cap of the container and the INLET of the hose **1**.

Note: the fine thread connects to the cap and the coarse thread connects to the hose **1** as shown.

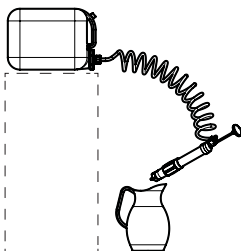

STEP 10

Purge the pump of air, locate the flow direction on the filter **7** and press the INLET end of the filter **7** firmly into the OUTLET end of the pump **2**. Begin pumping water into container as shown. Use Nozzle **10** if dispensing water without filtering.

HOW TO USE FILTER AS AN EMERGENCY STRAW

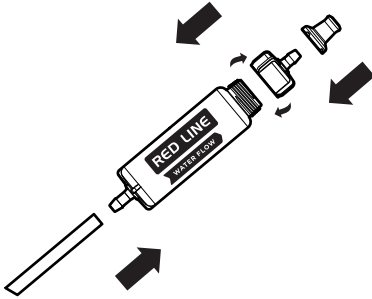

STEP 20

Remove filter 7 from pump 2. To attach straw 12, dip straight cut end of straw 1" deep into hot water. After 10-15 seconds remove and push over INLET barb 7. Attach mouthpiece 13 to barbed adapter 11 on the OUTLET of filter 7.

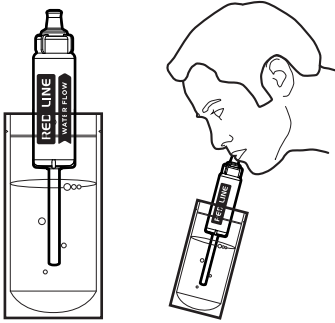

STEP 12

Fill pouch 14 (filter package) with water, immerse straw 12 into water and suck on mouthpiece to drink.

CAUTION — To avoid cross contamination: Do not handle filter with wet hands that been exposed to contaminated water. Do not submerge filter or mouthpiece in contaminated water.

MAINTENANCE AND STORAGE

Filter Storage

- Filter may be stored wet for short periods of time (<30 days). For long term storage (>30 days), remove filter from pump, remove adapter from OUTLET end of filter, shake out excess water, and allow to dry at room temperature for a minimum of 48 hours.
- Store in a cool, dry location.
- Do not store used filter in a sealed container.
- Do not freeze filter or expose filter to extreme temperatures.

Pump, Hose, and Fittings Storage

- Remove residual water from pump, hose, and fittings then allow to air dry.
- Store in a dry location away from direct sunlight and extreme temperatures.

TECHNICAL INFORMATION

FILTER CARTRIDGES



(INCLUDED)



(SOLD SEPARATELY)

PARAMETER	RED Line Series II Filter	GRN Line Series II Filter
Service Life	120 Gal. (454 L)	80 Gal. (303 L)
Flow Rate	up to 500 ml/min	up to 800 ml/min
Operating Temperatures	35-120° F (1.6-49° C)	35-120° F (1.6-49° C)
Operating Pressures	0-3 psi (0-0.211 kg f/cm ²)	0-3 psi (0-0.211 kg f/cm ²)

Use Conditions Use best water source available. Quality of the source water may vary. Use only Aquamira RED Line or GRN Line* Series II filters if biological quality of source water is uncertain. Aquamira® Water Treatment* (#67203) is recommended to treat water prior to long term storage.

*Sold separately

Removal

RED LINE		VIRUS PROTECTION
Virus Removal	≥99.99%	
Bacteria Removal	≥99.9999%	
Cyst Removal	≥99.95%	
Chlorine, Chemical, Taste & Odor Removal		
MEETS OR EXCEEDS ANSI/NSF 42		

GRN LINE		BACTERIA PROTECTION
Bacteria Removal	≥99.9999%	
Cyst Removal	≥99.95%	
Chlorine, Chemical, Taste & Odor Removal		
MEETS OR EXCEEDS ANSI/NSF 42		

REPLACEMENT & COMPATIBLE PARTS

PART #	ITEM NAME
67254	GRN Line All-in-One Emergency Water Kit (Replacement Filter)
67259	RED Line All-in-One Emergency Water Kit (Replacement Filter)
67276	WaterBasics Emergency Pump and Hose Kit

CERTIFICATIONS AND PATENTS



Certified by IAPMO R&T to US EPA Microbiological Purifier test standard for the reduction of cysts, bacteria and viruses. Certified to NSF/ANSI 372 for lead free content.

US Patent #D733847, #9162167
Other patents pending.

aquamira.

917 West 600 North, Logan, UT 84321

ph: (877) 644-4650

www.aquamira.com

© Copyright 2016 Aquamira Technologies, Inc.



aquamira®

IAPMO RESEARCH AND TESTING, INC.

5001 East Philadelphia Street, Ontario, California 91761-2816 – USA • 909-472-4100 • 909-472-4244 • www.iapmort.org



CERTIFICATE OF LISTING

IAPMO Research and Testing, Inc. is a product certification body which tests and inspects samples taken from the supplier's stock or from the market or a combination of both to verify compliance to the requirements of applicable codes and standards. This activity is coupled with periodic surveillance of the supplier's factory and warehouses as well as the assessment of the supplier's Quality Assurance System. This listing is subject to the conditions set forth in the characteristics below and is not to be construed as any recommendation, assurance or guarantee by IAPMO Research and Testing, Inc. of the product acceptance by Authorities Having Jurisdiction.

The most updated information on this Certificate of Listing is available online at pld.iapmo.org

Effective Date: March 2017 -Rev. 2/12/2018- Void After: March 2018

Product: Lead Free Water Filtration Product File No. W-9561

Issued To: Aquamira Technologies Inc
917 West 600 North
Logan, UT 84321

Identification: Each product shall bear permanent and legible markings to identify the manufacturer. This marking shall be the trade name, trademark, or other mark known to identify the manufacturer. The product shall bear the appropriate IAPMO R&T certification mark. The product may also bear either "Lead Free" or "Low Lead" above or in close proximity to the IAPMO R&T certification mark.

Characteristics: Products may include any pipe, pipe fitting, solder, flux, or other plumbing products providing water for human consumption. Products listed below are to be installed in accordance with the manufacturer's instruction. These products have been verified with weighted average lead content $\leq 0.25\%$; Solder and flux lead content $\leq 0.2\%$.

Products listed on this certificate have been tested by an IAPMO R&T recognized laboratory. This recognition has been granted based upon the laboratory's compliance to the applicable requirements of ISO/IEC 17025.

Products are in compliance with the following standard(s):
Section 1417(d) of the Safe Drinking Water Act

Chairman, Product Certification Committee

CEO, The IAPMO Group



This listing period is based upon the last date of the month indicated on the Effective Date and Void After Date shown above. Any change in material, manufacturing process, marking or design without having first obtained the approval of the Product Certification Committee, or any evidence of non-compliance with applicable codes and standards or of inferior workmanship, may be deemed sufficient cause for revocation of this listing. Production of or reference to this form for advertising purposes may be made only by specific written permission of IAPMO Research and Testing, Inc. Any alteration of this certificate could be grounds for revocation of the listing. This document shall be reproduced in its entirety.

IAPMO RESEARCH AND TESTING, INC.
CERTIFICATE OF LISTING

-Rev. 2/12/2018-

Void After: March 2018

Product: Lead Free Water Filtration Product

File No. W-9561

Issued To: Aquamira Technologies Inc

The lead content requirements of Section 116875 of the California Health &
Safety Code
NSF/ANSI 372-2016

IAPMO RESEARCH AND TESTING, INC.

CERTIFICATE OF LISTING

-Rev. 2/12/2018-

Void After: March 2018

Product: Lead Free Water Filtration Product

File No. W-9561

Issued To: Aquamira Technologies Inc

MODELS:

Model Number	Description
67005	Frontier Straw
67006	Frontier Pro Ultralight Filter
67013	Frontier Series III GRN Line Filter
67015	Frontier Filtered Water Bottle GRN
67018	Frontier Max Filtration System
67019	Frontier Series IV Red Line Filter
67020	Frontier Series IV GRN Line Filter
67022	Frontier Max Filtration System
67026	Frontier Filtered Water Bottle RED
67027	Frontier Series II GRN Line Filter
67028	Frontier Series II RED Line Filter
67031	Frontier Plus Replacement Filter
67033	Frontier Plus Home Emergency Water Storage Kit
67106	Frontier Pro Ultralight Filter Tactical
67109	Frontier Straw Tactical
67250	Emergency Straw Filter 2 pk
67252	WB Bag to Bag Filter Kit
67254	WB Series II GRN Line Filter
67256	Filtered Water Bottle GRN
67257	Emergency Pump and Filter Kit
67258	WB Filtered Water Bottle RED
67259	WB Series II RED Line Filter
67260	Water Storage Kit 60 gal w Filter
67261	Water Storage Kit 60 gal
67262	Water Storage Kit (Red-II-120)

IAPMO RESEARCH AND TESTING, INC.

CERTIFICATE OF LISTING

-Rev. 2/12/2018-

Void After: March 2018

Product: Lead Free Water Filtration Product

File No. W-9561

Issued To: Aquamira Technologies Inc

67263	Water Storage Kit 30 gal
67264	Water Storage Kit 60 gal w Filter AWT
67268	WB Filtered Water Bottle RED with replacement filter
67269	WB Filtered Water Bottle RED
67276	WB Emergency Pump and Hose Kit
67277	WB Water Storage Tank 60 gal
67278	WB Water Storage Tank 30 gal

IAPMO RESEARCH AND TESTING, INC.

5001 East Philadelphia Street, Ontario, California 91761-2816 • (909) 472-4100 Fax (909) 472-4244 • www.iapmo.org



CERTIFICATE OF LISTING

IAPMO Research and Testing, Inc. is a product certification body which tests and inspects samples taken from the supplier's stock or from the market or a combination of both to verify compliance to the requirements of applicable codes and standards. This activity is coupled with periodic surveillance of the supplier's factory and warehouses as well as the assessment of the supplier's Quality Assurance System. This listing is subject to the conditions set forth in the characteristics below and is not to be construed as any recommendation, assurance or guarantee by IAPMO Research and Testing, Inc. of the product acceptance by Authorities Having Jurisdiction.

The most updated information on this Certificate of Listing is available online at pld.iapmo.org

Effective Date: June 2017

Void After: June 2018

Product: Microbiological Water Purifier

File No. W-9953

Issued To: Aquamira Technologies Inc
917 West 600 North
Logan, UT 84321

Identification: The product or packaging shall be marked with the model number, name and address or manufacturer, functional description of system, max operating temperature, max working pressure, a statement noting that the system conforms to the EPA Guide Standard and Protocol for Testing Microbiological Water Purifiers as well as the IAPMO R&T Certification Mark.

Characteristics: The point-of-use and point-of-entry systems addressed by this Standard are designed to be used for the reduction of microbiological organisms (bacteria, virus, and cyst) that may be present in drinking water of unknown quality which are considered health hazards. To be used in accordance with the manufacturer's instructions.

Products listed on this certificate have been tested by an IAPMO R&T recognized laboratory. This recognition has been granted based upon the laboratory's compliance to the applicable requirements of ISO/IEC 17025.

Products are in compliance with the following standard(s):

US EPA Guide Standard and Protocol for Testing Microbiological Water

Chairman, Product Certification Committee

CEO, The IAPMO Group



This listing period is based upon the last date of the month indicated on the Effective Date and Void After Date shown above. Any change in material, manufacturing process, marking or design without having first obtained the approval of the Product Certification Committee, or any evidence of non-compliance with applicable codes and standards or of inferior workmanship, may be deemed sufficient cause for revocation of this listing. Production of or reference to this form for advertising purposes may be made only by specific written permission of IAPMO Research and Testing, Inc. Any alteration of this certificate could be grounds for revocation of the listing. This document shall be reproduced in its entirety.



IAPMO RESEARCH AND TESTING, INC.

CERTIFICATE OF LISTING

Page 2

Void After: June 2018

Product: Microbiological Water Purifier

File No. W-9953

Issued To: Aquamira Technologies Inc

Purifiers



IAPMO RESEARCH AND TESTING, INC.

CERTIFICATE OF LISTING

Page 3

Void After: June 2018

Product: Microbiological Water Purifier

File No. W-9953

Issued To: Aquamira Technologies Inc

MODELS:

Product Description	Model Number	Replacement Component	Reduction Claim
Non-plumbed Batch Systems:			
WaterBasics™ 60 gal Water Storage Kit w/Filter	67260	67529	Bacteria, Virus, Cyst
WaterBasics™ 30 gal Water Storage Kit w/Filter	67262	67529	Bacteria, Virus, Cyst
WaterBasics™ 60 gal Water Storage Kit w/AWT	67264	67529	Bacteria, Virus, Cyst
Frontier Max Multi-Function Filtration System	67018	67019	Bacteria, Virus, Cyst
Frontier™ Flow Water Bottle + Filter	67026	67028	Bacteria, Virus, Cyst
Frontier™ Replacement Bottle Filter	67028	67028	Bacteria, Virus, Cyst
Frontier Plus Replacement Filter	67031	67031	Bacteria, Virus, Cyst
Frontier Plus: Home Emergency Water Kit	67033	67031	Bacteria, Virus, Cyst
Water Basics™ Emergency Pump and Filter Kit	67257	67259	Bacteria, Virus, Cyst
Water Basics™ Filtered Water Bottle	67258	67259	Bacteria, Virus, Cyst
Water Basics™ Replacement Filter	67259	67259	Bacteria, Virus, Cyst